

MATERIAL:
DUCTILE IRON

OPW Engineered Systems

STYLE 58FO SWIVEL JOINT-CAST

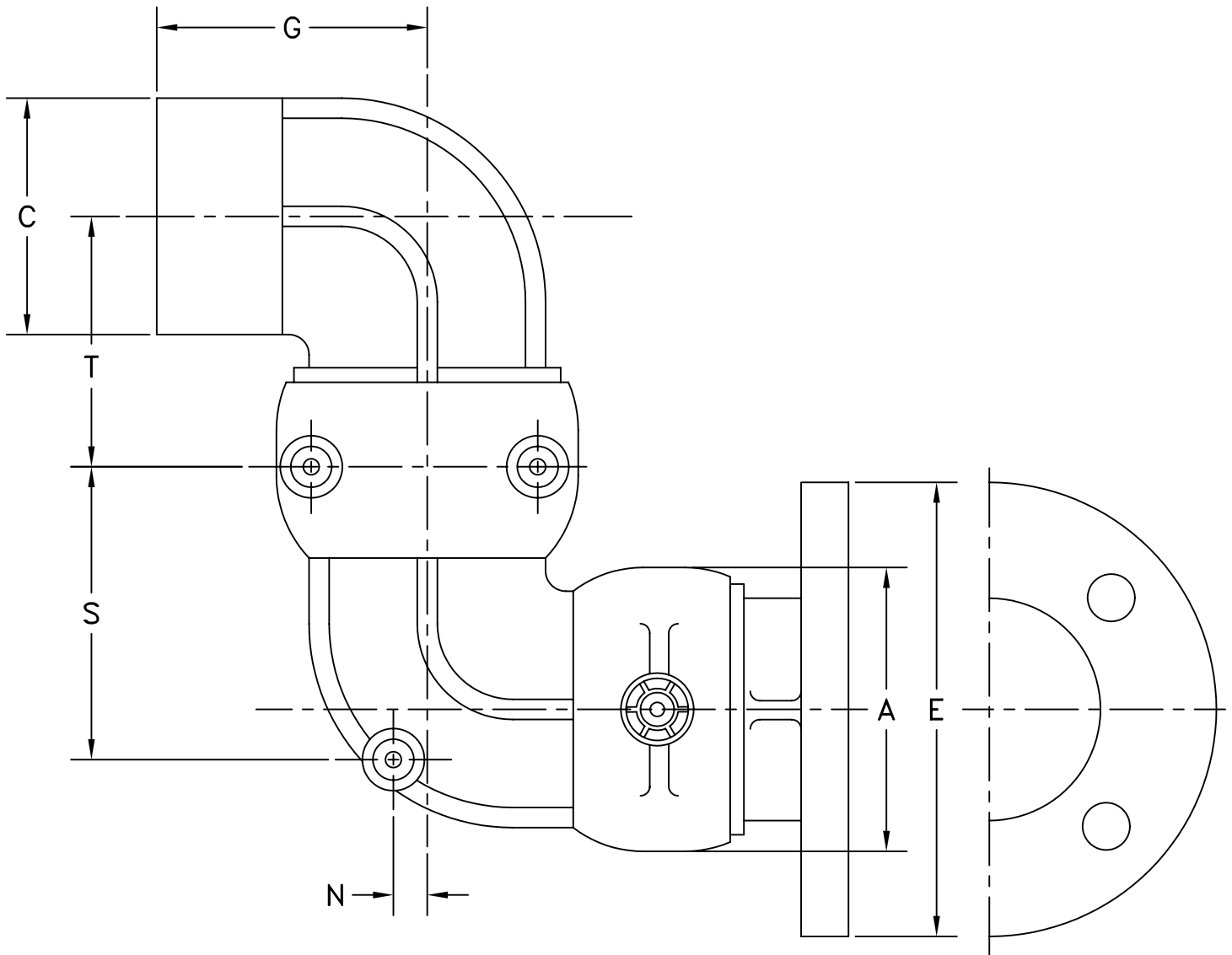

SIZE	3"	4"
A	4-7/8"	6-1/16"
C	4"	5"
E	7-1/2"	9"
F	7-5/8"	9-1/4"
G	4-5/8"	5"
H	6-7/8"	8-3/32"
N	1/4"	1/4"
S	13-15/16"	13-15/16"
T	4-9/32"	4-9/32"
∅ BOLT CIRCLE	6"	7-1/2"
NO. HOLES - ∅	(4) 5/8"	(8) 5/8"