

IMPORTANT INFORMATION FOLLOW ALL INSTRUCTIONS

NOTICE: OPW-FCS system components may only be installed and serviced by a factory trained and currently certified installer in order for the product warranty to be valid. The use of non-certified personnel or any deviations from these written procedures could result in damage or leakage of the system and void the product warranty. Contact OPW-FCS's Customer Service Department for more information at 1 866-547-1816.

Introduction

The FlexWorks Access Pipe conduit is a large diameter corrugated piping that adds additional protection to OPW-FCS's flexible piping and allows the pipe to be removed and replaced without excavation. Made of high density polyethylene, this corrugated tube is strong enough to withstand H-20 loading requirements when properly buried and thick enough to minimize damage from shipping and jobsite handling. FlexWorks Access Pipe can accommodate the 3/4", 1", 1-1/2", 2" and 3" FlexWorks supply pipe. The Access Pipe can also be air tested and used as an additional element of containment for OPW-FCS FlexWorks Piping.

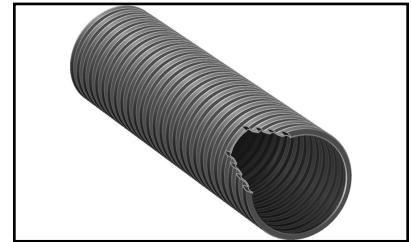

Note: Access Pipe is not intended as secondary containment.

Pipe Burial Requirements

Trench Sizing

Piping trenches should be dug in such a manner that the trench width is equal to at least twice the width of all the flexible pipes contained within. All piping within the trench should be separated by a minimum of 4" (102 mm). Trench turns should be sweeping rather than at sharp angles. The bottom of the trench should be compacted and as uniform as possible to eliminate high spots and to insure an even layer of bedding material under the pipe. Remove all sharp rocks and debris from the trench bottom before bedding material is installed.

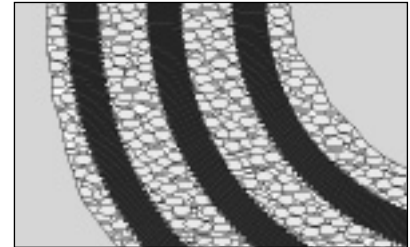
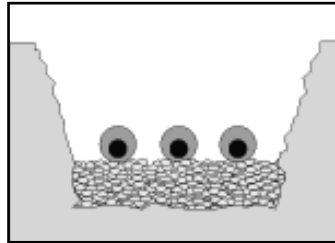

Bedding & Backfill Materials

Approved bedding and backfill materials for OPW-FCS's FlexWorks Piping System shall meet the following specifications:

Pea Gravel

Rounded pea gravel is permitted with a minimum diameter of 1/8" and a maximum diameter of 3/4".

Crushed Stone

Crushed stone is permitted providing it shall be washed clean and be of the free flowing type with an angular stone size between 1/8" and 1/2". (Meets ASTM C-33 paragraph 9.1 requirements.)

Sand

Sand backfill is permitted providing it shall be washed clean and is free flowing with a maximum content of 10% fines. When backfilling, make sure sand is evenly distributed and fully compacted under and around the piping.

NOTE: A minimum of 6" (150mm) of approved bedding material shall be spread and compacted evenly along the bottom of the piping trench. All bedding and backfill material should be clean and free from ice, snow and debris. Using material other than those described above without written approval from OPW-FCS will void the product warranty.

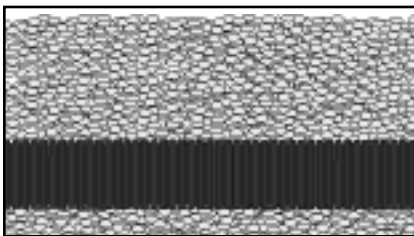

Unpaved Surface

If the surface is unpaved, a minimum of 16" (406mm) of approved backfill material should be installed between the top of the Access Pipe and the top of the ground surface.

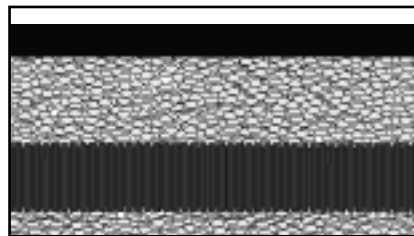

Asphalt Surface

For asphalt, a minimum of 16" (406mm) of approved backfill material should separate the top of the Access Pipe from the top of the asphalt.

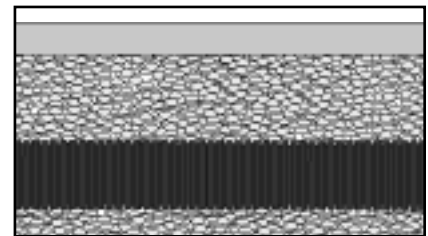

Concrete Surface

For reinforced concrete, a minimum of 16" (406mm) of approved backfill material should separate the top of the Access Pipe and the top of the concrete.

Backfilling

Backfilling of the FlexWorks Piping System should occur only after the final integrity testing has been performed on both the primary and the secondary of the pipe. Prior to backfilling completely, hand shovel the backfill material between and to the outside of the pipe to maintain the minimum required spacing between the pipes and walls of the trench. Final backfilling shall be done slowly and evenly in 4" to 6" layers as not to disturb the spacing of the pipe and to insure no voids are present in the backfill. An additional air test is recommended after backfilling to insure the backfill process has not damaged the pipe.

CAUTION: Access Pipe can be punctured by grade stakes or other sharp objects driven into the ground. The use of tracer tape or a schematic of the underground piping should be kept onsite and marked off prior to commencing any work that may damage the pipe.

FlexWorks Access Pipe Specifications

| Part # | Application | Min. Bend Radius | | Packaging | Dimensions | | | |
|-----------|----------------------------|------------------|-----|------------|------------|-----|-------|-------|
| | | in | mm | | I.D. | | O.D. | |
| AXP30-500 | 3" Double Wall Access Pipe | 36 | 900 | Box 500 ft | 3 | 76 | 3.536 | 89.8 |
| AXP30-250 | 3" Double Wall Access Pipe | 36 | 900 | Box 250 ft | 3 | 76 | 3.536 | 89.8 |
| AXP30-100 | 3" Double Wall Access Pipe | 36 | 900 | Box 100 ft | 3 | 76 | 4.760 | 89.8 |
| AXP40-250 | 4" Double Wall Access Pipe | 36 | 900 | Box 250 ft | 4 | 102 | 4.760 | 121.0 |
| AXP40-100 | 4" Double Wall Access Pipe | 36 | 900 | Box 100 ft | 4 | 102 | 4.760 | 121.0 |

Access Pipe Entry Boot Installation

Access Pipe Entry Boots

These rubber boots are designed to seal pipe entries for underground applications. For proper installation, the appropriate size fabrication template should be used for accurate hole drilling. The appropriate hole saw size must be used for the Access Pipe Entry Boot.

NOTE: When installing Access Pipe with Coax couplings and certain entry boots, it may be necessary to install the FlexWorks pipe prior to coupling. Refer to the FlexWorks Flexible Underground Piping Manual for further details.

Step #1

Locate the center entry point in the flat wall section of the sump base and drill a 5/16" hole. Install the Entry Boot Template to the sump base wall using a 1/4" bolt and nut. Drill out the appropriate bolt hole circle for the Access Pipe Entry Boot, using the same 5/16" drill bit. After drilling, remove the template from the sump wall.

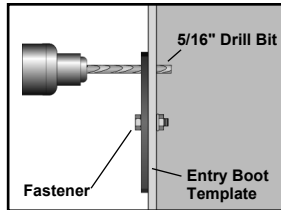

Step #3 (two-piece boot)

Install the encapsulated studded ring from outside the sump by inserting the studs through the bolt holes. From the inside of the sump, install the inside portion of the entry boot and compression ring over the studs then install nuts by hand.

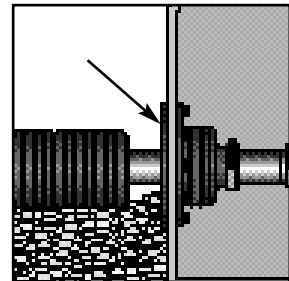

Step #2

After the bolt hole circle has been drilled, drill out the entry boot opening using the appropriate sized hole saw. After drilling out hole, clean any rough edges with a razor knife or deburring tool.

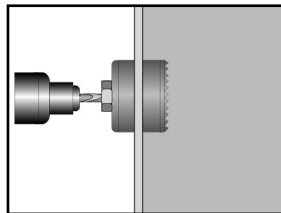

Step #4

Using a 7MM nut driver or wrench, tighten all of the nuts evenly in a clockwise sequence until 60 inch/lbs is attained on all nuts. This may require two to three revolutions to achieve. To prevent deformation of the boot do not over tighten nuts.

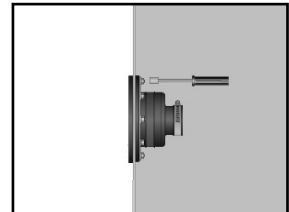

IMPORTANT

The appropriate hole saw size must always be used for proper installation and warranty coverage of all OPW-FCS Access Pipe Entry Boots.

Access Pipe Installation

Step #1: Measuring Access Pipe Conduit

Once the Access Pipe Entry Boots are installed, measure the distance from the wall of the first sump to the wall of the second sump. When measuring, it is important to consider that the pipe is flexible and will not be installed perfectly straight. A slight weaving of the pipe in the piping trench is recommended to compensate for expansion and contraction characteristics of the piping. Make sure to follow the contour of the trench. Subtract 1" from this figure and transfer the measurement to the Access Pipe. Make the cut in the closest valley using a fine tooth hack saw or utility knife. Make sure valley of corrugation is trimmed evenly.

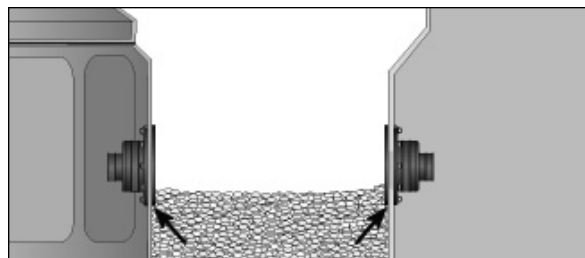

Step #2: Installing Access Pipe Conduit

Insert the Access Pipe into the flexible boot from outside of the sump. Be sure the end of the Access Pipe is flush with the inside face of the boot. Do not tighten band clamps at this time.

NOTE: Make sure the Access Pipe stiffener is inserted into the end of the Access Pipe.

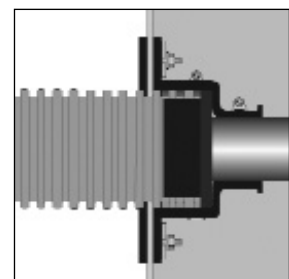
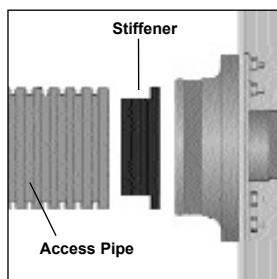

(Cutaway)

Measuring FlexWorks Piping

Step #1

Install riser pipes and fittings as required. Risers in Dispenser Sumps must be aligned to match dispenser inlet locations.

Step #2

Feed the measuring tape through the Access Pipe and measure the distance from the face of one fitting (Adapter, Tee or Elbow) to the face of the adjacent fitting using a measuring tape inside the duct.

- Swivel Fittings: Subtract 1" from this measurement and cut the FlexWorks Piping to that length.
- Barbed Fittings: For barbed fittings, measure from shoulder to shoulder.
- Coax Fittings: Cut the FlexWorks Piping to the measured length.

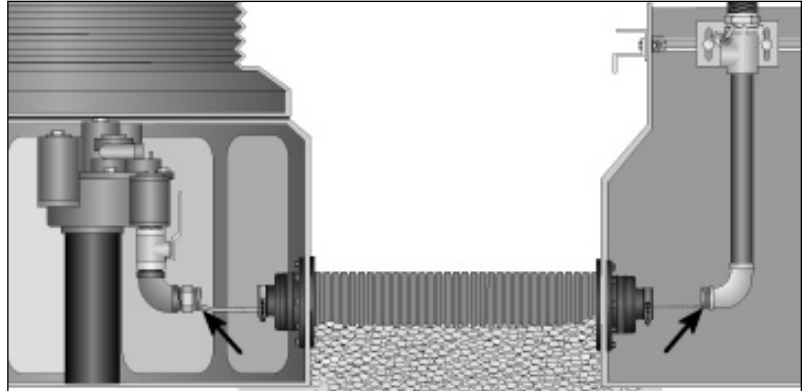

Installing FlexWorks Piping in Access Pipe

Step #1

Remove Access Pipe Conduit from entry boots. Attach the appropriate OPW-FCS Bullnose to one coupling. Fish rope through the Access Pipe Conduit and attach to Bullnose if needed. Push and/or pull FlexWorks piping through Access Pipe Conduit. For Barbed fittings, insert bullnose plug and push piping through duct.

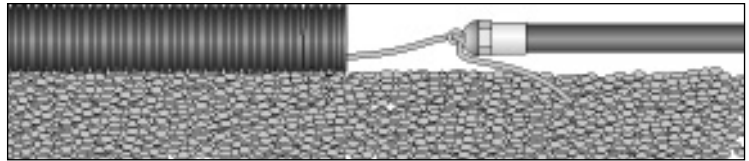

Step #2

Align the Access Pipe / FlexWorks Piping with the entry boot. Push piping through Entry Boot and attach coupling to the fitting in accordance with the installation instructions found in the FlexWorks Piping Manual.

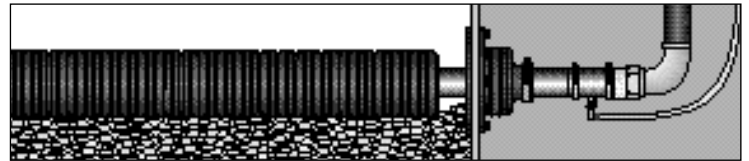

NOTE: Inner half of boot may be removed to facilitate feeding piping through boot.

Step #3

Insert the Access Pipe into the Entry Boot. Secure the ducting by tightening the large band clamp to 30 in. lbs.



Step #4

Repeat Steps #2 & #3 above for the opposite end of the piping.



Step #5

Once all piping connections have been made, position all donuts if required and tighten the small band clamp to 30 in/lbs. Repeat for all Entry Boots.

WARNING: Do not exceed 30 in/lbs. Overtightening of the band clamps can cause damage to the entry boots and pipe over time.

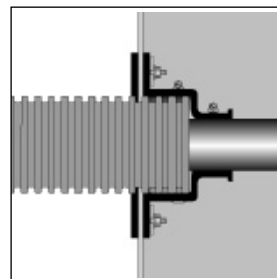

Swivel or Barbed Fittings

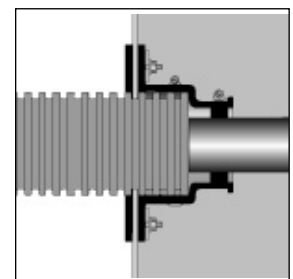

Coax Fittings

Optional Air Testing

The Airstem supplied with some entry boots and donuts permit Access Pipe testing. Air testing is performed by placing an inline gauge with a metering valve onto the airstem and slowly pressurizing the Access Pipe to no more than 5 PSI. Use a soapy solution to check for leaks. Do not over pressurize the Access Pipe.

WARNING

Keep all fiberglass cleaning solvents away from boots. These types of solvents could cause severe damage.

NOTE

The Access Pipe may expand slightly under pressure. Removing air pressure after the test will allow the Access Pipe to return to its original length.

WARNING

Integrity testing with air or gas can be dangerous and it is very important that the proper test equipment be used by qualified personnel.



3250 US 70 Business West
Smithfield, N.C., 27577-0330
Customer Service: 1-866-422-2525
Customer Service Fax: 1-800-421-3297
Technical Service: 1-866-547-1816
www.opwfcs.com