

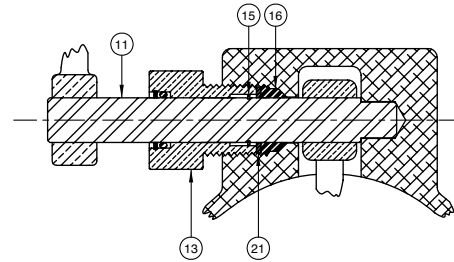

VA4112 5" X 4" Emergency Valve

Replacement Parts

Rev. 0, January 2003

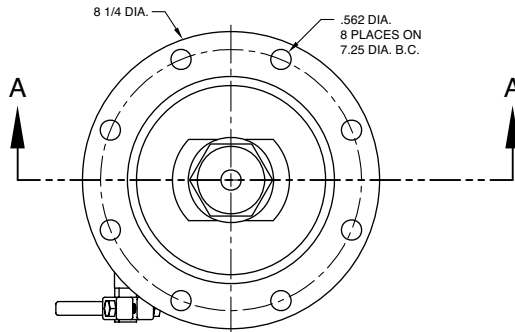

SECTION B-B

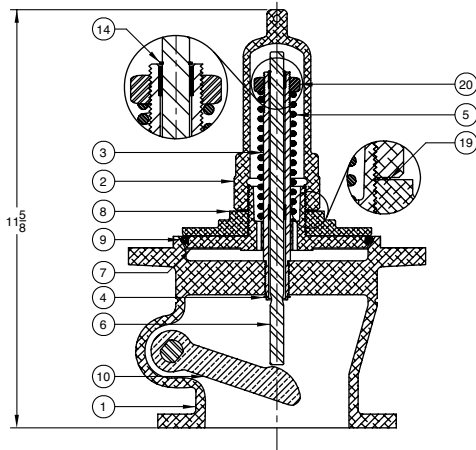

SECTION A-A

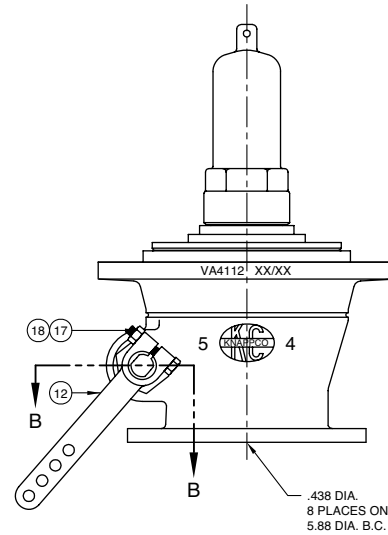

ITEM	PART NUMBER	DESCRIPTION	QTY.
1	5083	VALVE BODY	1
2	7363	CAP	1
3	2899	STEM ASSEMBLY	1
4	6099	RETAINING RING	1
5	5215	SPRING	1
6	7231	PUSH ROD	1
7	5087	DISC	1
8	7865	DISC LOCK NUT	1
9	7342	O-RING (TEF-O-SIL)	1
10	7898	LIFT LEVER (BRASS)	1
11	7909	LEVER SHAFT	1

ITEM	PART NUMBER	DESCRIPTION	QTY.
12	6117	HANDLE	1
13	6427	GLAND ASSY (BRASS/TEF-O-SIL)	1
14	4094	RETAINING RING	2
15	2198	RETAINING RING	1
16	7117	PACKING (TEFLON)	2
17	5684	SCREW	1
18	5685	HEX NUT	1
19	8041	GASKET (TEFLON)	1
20	5687	JAM NUT	1
21	6024	WASHER	1