



**SaVD Lite Gate Valve Series**

Safe Vent & Drain Safety Seal Cap / Hose Half



**High Pressure Safety Seal Cap**  
 ANSI 1500 & 2500 Class

**"Lite" Series Safety Seal Cap**  
 ANSI 800 and below

**High Pressure  
 Hose Half Assembly**

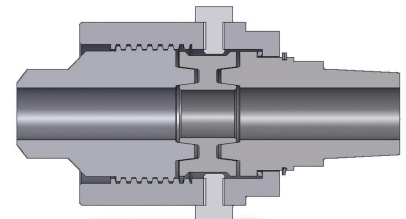
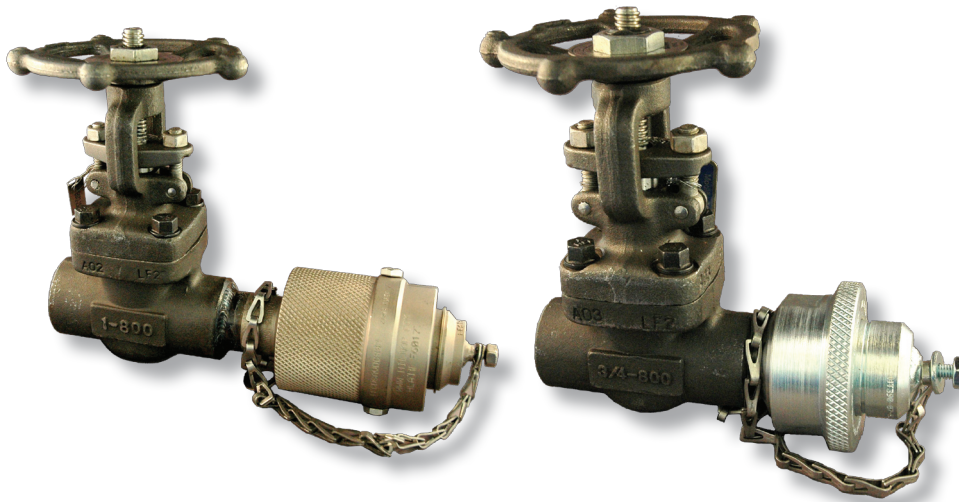

Male NPT Hose Connection

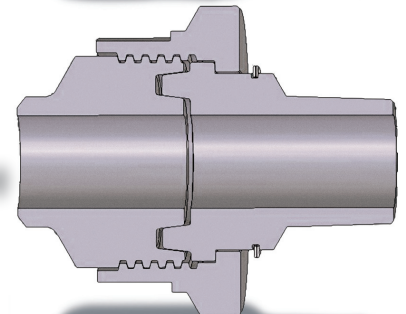

Lite Series Hose Half Assembly



Conventional Bull plugs allow thread to come in contact with liquid, drastically shortening the plug's life.

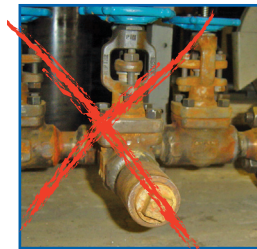

Corrosion and rust make the traditional Bull Plug dangerous, even lethal to handle in some cases



Corrosion resistant materials, a high strength safety chain and Hiltap's patented design allows this sealing cap to be the most efficient and safe design available

**Advantages**

- The SaVD Safety Seal Cap is designed to replace high pressure bull plugs used in venting & draining SAGD steam and heavy oil piping.
- Safety Seal Cap locks under residual / line pressure
- Safety Seal Cap can be retightened to seal
- Outer seal & locking threads are located OUTSIDE the wetted surfaces
- All caps have chains
- Valve mounted couplings halves can be safely rodded, steam cleaned, pressure purged with specially designed & CRN registered adapters.
- CRN's exist
- NACE materials of construction

**Valve Advantages**

- Certified to ISO 9001, API 6D, CE/PED, TA Luft fugitive emissions test approval
- Pressure classes 800#, 1500#, 2500#
- Materials include A105, LF2, F11/22, F304, F316L
- NACE MR0175
- CRN's exist
- Vendor Approval Program acceptance
- Solid Material Wedge, NO overlays.





**Engineered Systems**  
PART OF OPW FLUID TRANSFER GROUP  
A DUCED COMPANY

- PIPE, TUBING, AND HOSE COUPLING SEALING SOLUTIONS
- PROCESS PIGGING
- PRODUCT RECOVERY TECHNOLOGIES



## SaVD Lite Gate Valve Series

Safe Vent & Drain Safety Seal Cap / Hose Half

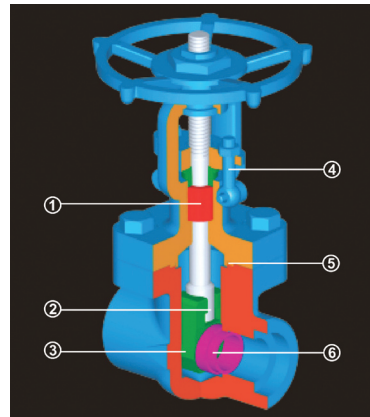
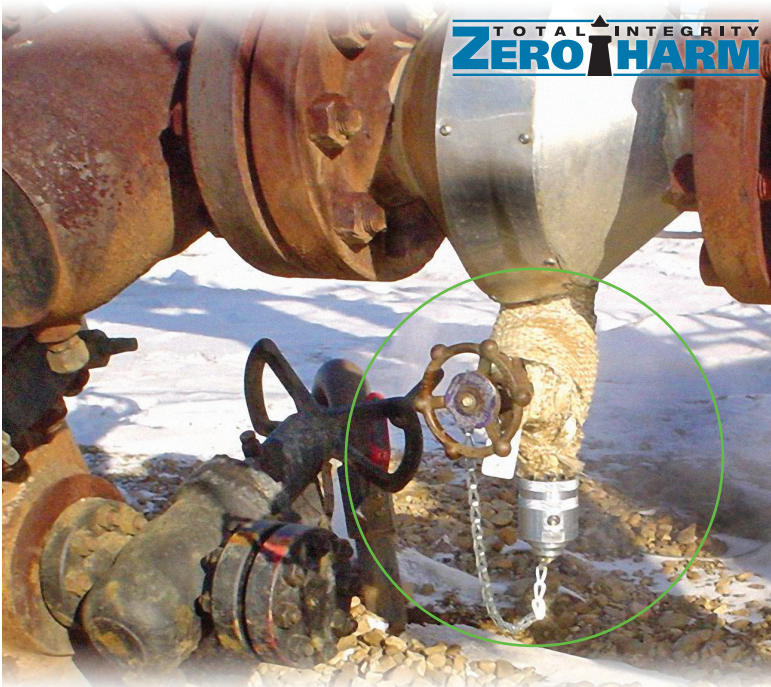

- ① Safe and tight stem seal by means of positive back seat and long life leak proof stuffing box design.
- ② The T-head connect of stem and disc assuring easy seating operation.
- ③ Solid fully guided wedge reducing wear on seating surfaces.
- ④ Gland eyebolts facilitating packing maintenance.
- ⑤ Leak proof Body-Bonnet Joint Cavity to eliminate the unwinding of the SS spiral metal.
- ⑥ Rolled-in seat to assure tight and effective seating.

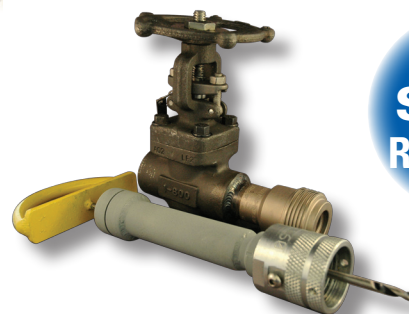

**Now Safely Roddable**

### Available sizes

- 3/4" 1.91 cm
- 1" 2.54 cm
- 1 1/2" 3.81 cm
- 2" 5.08 cm

Other sizes available upon request

### End configuration

Butt weld, socket weld, NPT (male and female).  
Others available upon request

The Safest, Most Reliable Safety Seal Cap ever.

Safe, Environmentally friendly, Quality products.  
Patented, Patents pending.  
1-800-661-6150 Toll-free  
(403) 250-2986 Canada (403) 291-3592 Fax  
[www.hiltap.com](http://www.hiltap.com)

Distributed by: \_\_\_\_\_ 05/2008