

Installation Instructions

Stabilizer Bar Kits

Dispenser Sumps

IMPORTANT: Please read all warnings and follow the installation instructions completely and carefully. Failure to do so will void all warranties and may cause product failure, or result in environmental contamination due to liquid leakage into the soil, creating hazardous spill conditions

WARNING - DANGER: Using electrically operated equipment near gasoline or gasoline vapors may result in fire or explosion, causing personal injury and property damage. Be sure that the working area is free from such hazards, and always use proper precautions.

Dispenser Sumps

FlexWorks Dispenser Sumps are installed beneath fuel dispensers to provide access to and secondary containment of fuel dispensers and piping connections. FlexWorks Emergency Valve Stabilizer Bar Kits are required to install boss mounted emergency shut-off valves in FlexWorks Dispenser Sumps. Use only OPW Fueling Containment System supplied hardware and components.

Mounting the Dispenser Sump in the Island Form

Dispenser sumps are typically mounted inside of permanent metal island forms. The sump must be mounted so that the top of the sump mounting frame is flush with the finished concrete surface of the island. The sump must be secured in the island form prior to backfilling and concrete pouring. Brackets formed into the sides and ends of the sump mounting frame can be used to mount the sump in the island form. The sump can be supported by attaching the brackets to the top of permanent support bars inside the island form or by attaching the brackets to the bottom of 2x4's spanning the top of the island form.

Step #1 (See Figure 1)

Attach a boss mounted emergency shut-off valve to the valve mounting plate using the three (3) flat-head Allen screws provided. Tighten securely. (Plate and screws supplied in stabilizer bar kit).

Step #2 (See Figure 2)

Thread a riser pipe (or flex connector) into the bottom of the emergency shut-off valve. Thread the FlexWorks tee (if the connection is to be a junction) or FlexWorks elbow (if the connection is to be an end connection) onto the bottom of the riser pipe. The riser pipe length should be sized so that when the emergency shut-off valve shear groove is flush with the island finish grade, the centerline of the FlexWorks tee or elbow is in line with the associated pipe entry fittings.

Determining Pipe Entry Height

Pipe entries are generally located as close to the bottom of the dispenser sump as possible. However, to maintain the proper piping slope back to the UST, it may be necessary to raise the height of the pipe entries into the dispenser sump. If locating the pipe entries higher on the sump wall does not provide adequate piping slope, the sump mounting frame can be lowered to allow the pipe entries to be located higher. Loosen the sump mounting frame and side struts. Slide the frame down to the proper height and reattach side struts. Cut off the excess top section of the sump leaving a 1" rain lip above the frame.

Step #3 (See Figure 3)

Install the necessary FlexWorks pipe and conduit entry fittings into the dispenser sump wall at the proper locations. The location of each pipe entry fitting should correspond with the product inlet locations for the dispenser that is to be installed. (Refer to the appropriate FlexWorks Entry Fitting Installation Instructions).

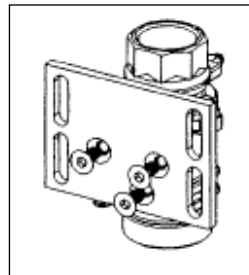

Figure 1

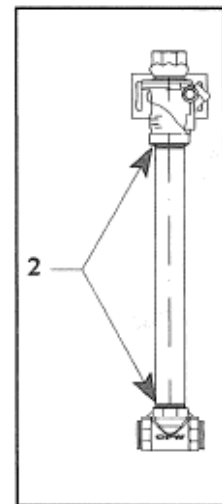

Figure 2

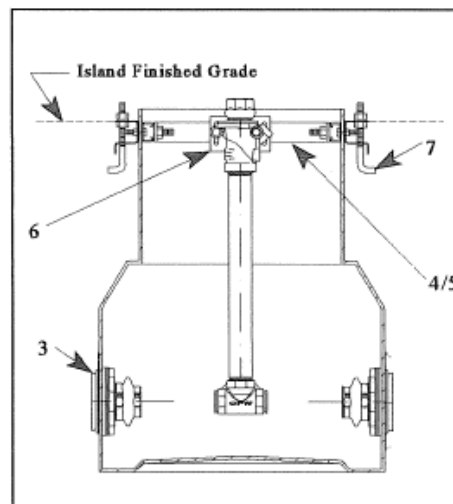

Figure 3

Step #4 (See Figure 4A/4B)

Insert the spring loaded clamp nuts into dispenser side struts and rotate into position. Four (4) clamp nuts are used for each stabilizer bar (Clamp nuts come in stabilizer bar kit).

Step #5 (See Figure 5A/5B)

Install the FlexWorks emergency valve stabilizer bars to the side struts in the dispenser pan. Loosely attach the appropriate FlexWorks stabilizer bars to the side struts by fastening the bolts complete with lock washers to the clamp nuts previously installed in the side struts. Shims are provided to insert into the gap between the bar and the side struts if necessary (Bolts, lock washers, shims come in stabilizer bar kit).

Step #6 (See Figure 6A/6B)

Insert the riser pipe assembly into the dispenser sump and attach the emergency shut-off valve plate to the stabilizer bar using two (2) U-bolts, washers, and lock washers. Follow the emergency shut-off valve mounting instructions to ensure proper valve positioning. Adjust entire assembly as necessary and then secure all stabilizer bar and shear valve mounting hardware. Tighten securely. (Stabilizer bar, U-bolts, washers, and lock washers are supplied in stabilizer bar kit).

Step #7

Install the provided concrete anchor bolts in the set of holes in the sump mounting frame that match the footprint of the dispenser to be installed (**Note: Make sure bolts are in correct holes before pouring concrete**).

Backfilling

Rounded pea gravel with a minimum diameter of 1/8" and a maximum diameter of 3/4" should be used for backfill around FlexWorks Dispenser Sumps. To prevent sump distortion, avoid dumping pea gravel directly onto the dispenser sumps when backfilling.

Notice: FlexWorks products should be used in compliance with applicable federal, state, and local laws and regulations. Product selection should be based on physical specifications and limitations and compatibility with the environment and material to be handled. OPW makes no warranty of fitness for a particular use. All illustrations and specifications in this literature are based on the latest production information available at the time of publication. Prices, materials, and specifications are subject to change at any time, and models may be discontinued at any time, in either case, without notice or obligation.

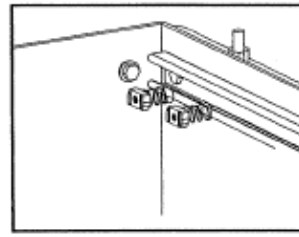

Figure 4A

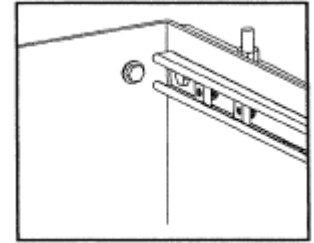

Figure 4B

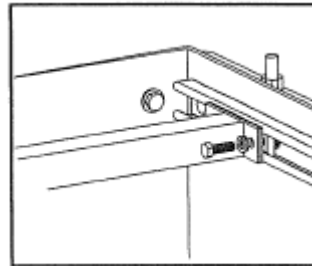

Figure 5A

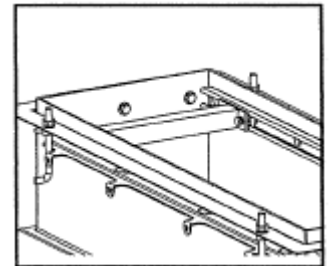

Figure 5B

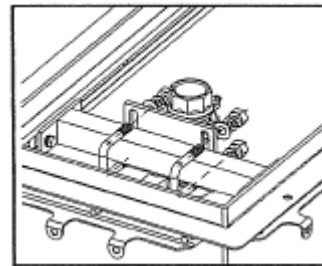

Figure 6A

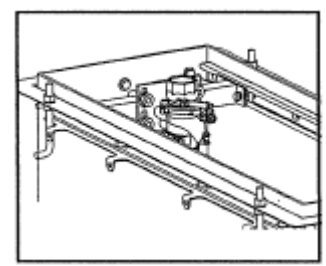

Figure 6B

IMPORTANT INFORMATION - FOLLOW ALL INSTRUCTIONS

Please contact your OPW-FCS sales representative or OPW-FCS customer service representative at 1-800-422-2525 for OPW-FCS products installation procedures. All OPW-FCS literature including installation instruction sheets and manuals can be accessed from the OPW-FCS website at: www.opwfcs.com.